

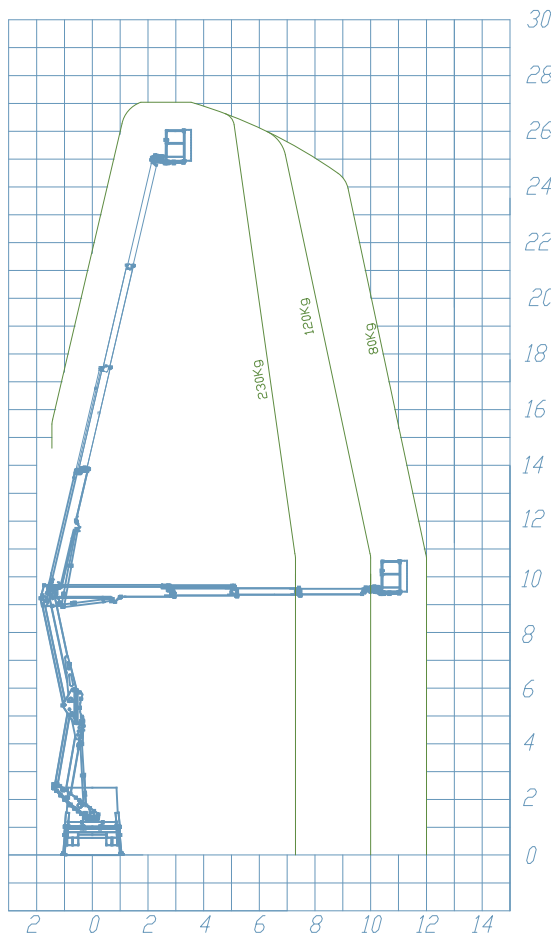











WORKING DIAGRAM



-  **OUTRIGGERS**
Vertical H+H
-  **WORKING HEIGHT**
27 m
-  **BASKET HEIGHT**
25 m
-  **MAX OUTREACH**
12 m
-  **BASKET LOAD CAPACITY**
230 kg
-  **BASKET SIZE**
1400 x 700 x 1100 mm
-  **CONTROLS**
Electric
-  **TURRET ROTATION**
700°
-  **GVW**
3,5 ton

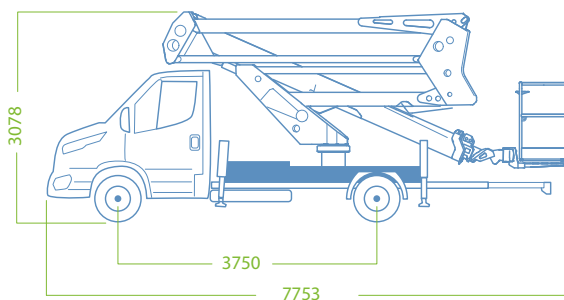

STANDARD ACCESSORIES

[a] AUTOMATIC STABILIZATION

The **SPEED** function is a new solution present in Socage's Aerial Working Platforms on Chassis. It brings great advantages including increasing safety and facilitating the correct use of the necessary stabilization maneuver to start working. With a single button, even from the basket, it allows to obtain stabilization in a safe, simple and fast way, quickly overcoming the irregularities of the ground.

DATA SHEET

- Aluminum Basket: 1400 x 700 x 1100 mm
- Hydraulic basket rotation 90 + 90
- Turret rotation 700°
- Pipes and hoses inside the booms
- **Automatic closing**
- **Automatic SPEED stabilization from the basket and from the ground**
- H + H vertical outriggers
- Proportional electrohydraulic controls with regulation of the speed of all movements
- Electronic safe system CAN BUS
- 4 plates to stand on the ground
- Socket 230V and 12V in the basket
- Possibility of simultaneous movements
- Automatic regulation of engine revolutions
- Aerial part centering light on the basket
- Automatic motor speed adjustment
- **Basket front support**
- **Cataphoresis treatment with powder coating**

SAFETY DATA

- **Socage Security System**
- Unintentional maneuver protection bar
- Controls protection of the basket
- Circuit breaker with differential protection on the 230V line
- Safety bypass for operator rescue
- Automatic stabilization
- Moment limiting device with double security
- Self levelling system for the basket
- Inclinator
- Flanged block valves
- Emergency button
- Emergency manual hand pump
- Possibility emergency remote rescue
- Automatic PTO deactivation
- Sensor anti crash smart cab
- Electrical hour counter
- Cab light closed outriggers
- Maintenance light

* Dimensions can change according to the assembly





SOCAGE, AERIAL PLATFORM CONSTRUCTOR ALL OVER THE WORLD



Socage, based in Modena, Italy, produces and sells truck mounted Aerial Working Platforms all over the world. With more than 40 years of experience, Socage is among the top experienced companies in the field.

Our products are of high quality and technologically advanced. Most notably, we stand out in the market for our reliability, ease of use, and performance.



forSteel



MY SOCAGE

From your smartphone, tablet or pc via My Socage you can:

- Connect your platforms to Socage's software
- Find spare parts quickly and easily
- Request remote diagnosis via Socage Connect
- Manage the working hours of your platforms

My Socage connects your platforms with what matters the most to you.

Welcome to Socage Universe

